



NEABSORBANT
REZISTENT LA SOCURI
INSTALARE RAPIDA
ANTI BACTERIAN
SISTEM PREFABRICAT
SECURITATE ALIMENTARA HACCP

Protectia igienica a peretilor

DESTINAT INDUSTRIEI AGRO-ALIMENTARE, CAMERELOR FRIGORIFICE, INDUSTRIEI FARMA,...



www.polysto.com

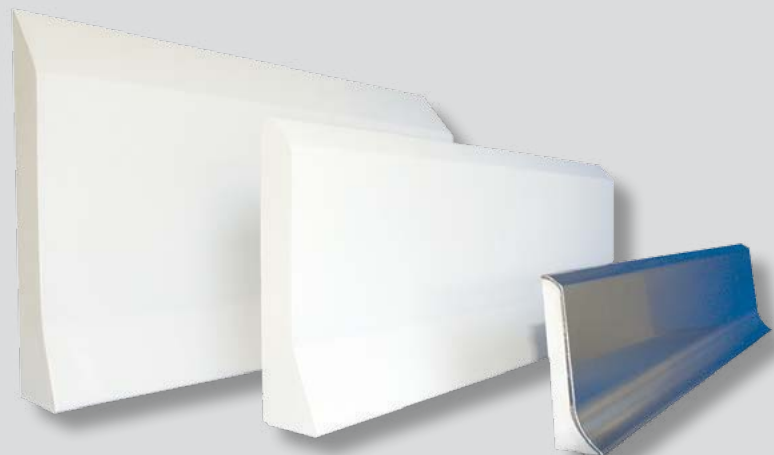

NIVEL DE PROTECTIE 1



PV8F PVC

PV15F PVC

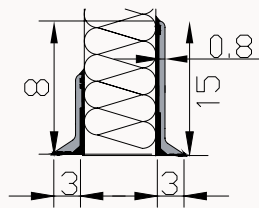

OP10F

FCF

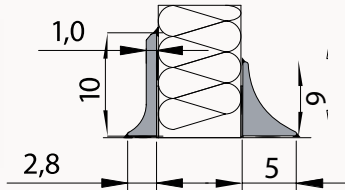

NIVEL DE PROTECTIE 2



OP16F CU PICIOR

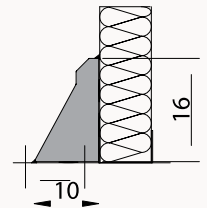
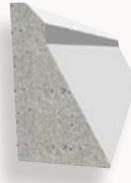

OP20F CU PICIOR

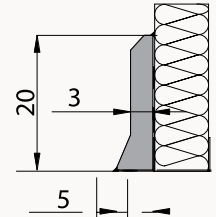

NIVEL DE PROTECTIE 3



OP30F CU PICIOR

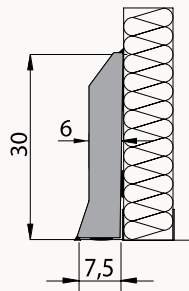

OP30RB CU DEGAJARE

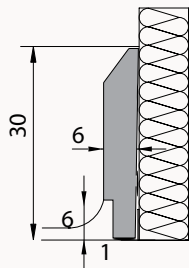

OP30RB CLEAN ROOM CU DEGAJARE

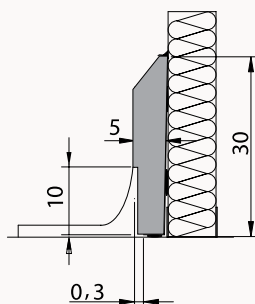

NIVEL DE PROTECTIE 4



IP 40 CU PICIOR

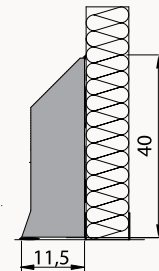

IP 30-40-50 CU DEGAJARE SAU DREAPTA

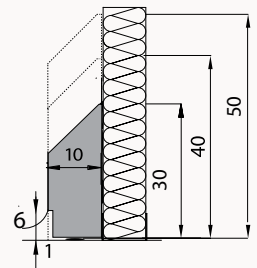
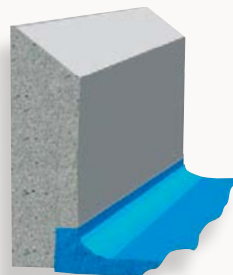

HPF CU PICIOR

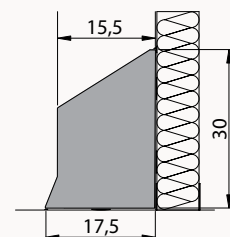

STRAT RASINA SANITARA

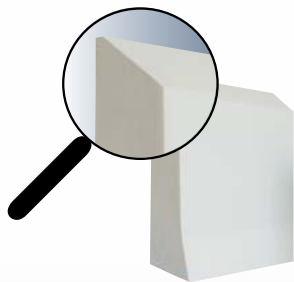

PolySto OP30RB cu degajare pentru racordul cu pardoseala epoxi in forma de scafa.

INOX

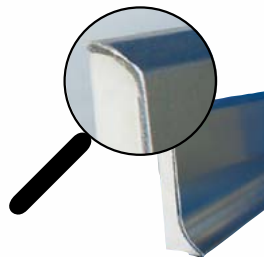

PolySto OP20F inox instalata pe o pardoseala epoxi deja realizata .

PolySto Sanicoat este o plinta impermeabila cu un strat de finisare neted usor de intretinut si rezistent la toti dezinfectantii industriali.

Toata gama de plinte PolySto este livrata standard cu un strat de INOX AISI 304L de 1,2mm grosime. Pentru alte grosimi si aspect AISI 316L – la cerere.

INSTALARE-INTRETINERE-ACCESORII



Castig de timp si bani!

Livrare rapida gratie unui sistem unic prefabricat.



Usor de intretinut si de reparat!

O gama completa de produse de curatire si intretinere.

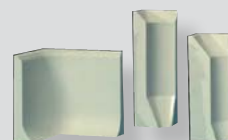

COLTURI INTERIOARE

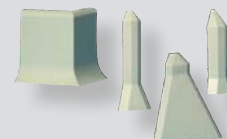

COLTURI EXTERIOARE



TERMINATII STANGA SI DREAPTA USII



OP30SF SMALL – PLINTE CREATE PENTRU PROTECTIA SPATIULUI DIN SPATELE USILOR CULISANTE

PolySto Hard Fix Glue: Adeziv MS polimer hibrid – uscare rapida, flexibil, foarte rezistent, anti –mucegai si impermeabil.

PolySto Chemfix: Un adeziv epoxi bicomponent foarte puternic pentru ancorarea chimica a bordurilor PolySto.

PolySto Cleaner Sanicoat sau Inox: Pentru o perfecta intretinere a plintelor si bordurilor d-voastra marca PolySto.

PolySto Kit de Reparatie: Pantru repararea stratului superior, a colturilor si terminatiilor bordurilor PolySto.

ROSTUIRE AGREATA AGROALIMENTAR – SANISEAL

PolySto rostuire agreata in ind agroalim.

PolySto silicon monocomponent neutru tratat fungicid si usor extrudabil. Se livreaza in culori alb, transparent si gri/inox, stabil la UV.

PolySto Saniseal (sudura chimica) Este o rostuire bi-

component cere creeaza o legatura foarte puternica. Se livreaza in culoare alb nealterabil, transparent si gri/inox.

Flexibilitate: 15%



PolySto OP30F instalata pe o pardoseala deja realizata, finalizand cu rosturi agreate in industria agroalimentara.



PolySto OP30RB Sanicoat cu degajare pentru racordarea cu pardoseala in forma de scafa. Finalizat cu PolySto Saniseal.

POLYSTO BANDA DE PROTECTIE DIN POLIETILENA - PE500

Instalata cu banda autoadeziva sau cu suruburi din otel inoxidabil si capace.

Benzile de protectie din polietilena sunt disponibile in toate dimensiunile si culori tip RAL.

Calitate: Minim PE500

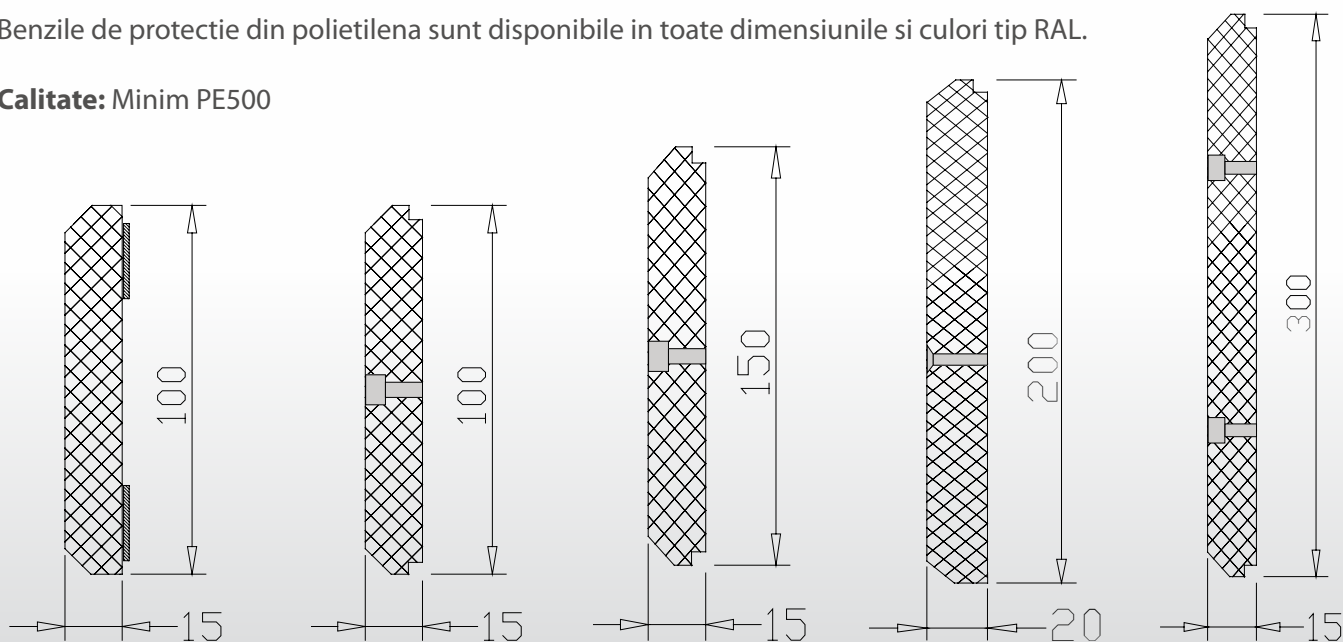

PolySto OP20F instalate pe pardoseala de beton si cu benzi de protectie din polietilena.



PolySto OP30RB (cu optiunea impact extrem) cu degajare pentru ridicarea pardoselii in forma de scafa. La parte de sus benzi de protectie din polietilena rosie si albastra.

POLYSTO IMPACT EXTREM



PolySto OP30F cu optiunea impact extrem (autoadeziv) montata pe placi ceramice.

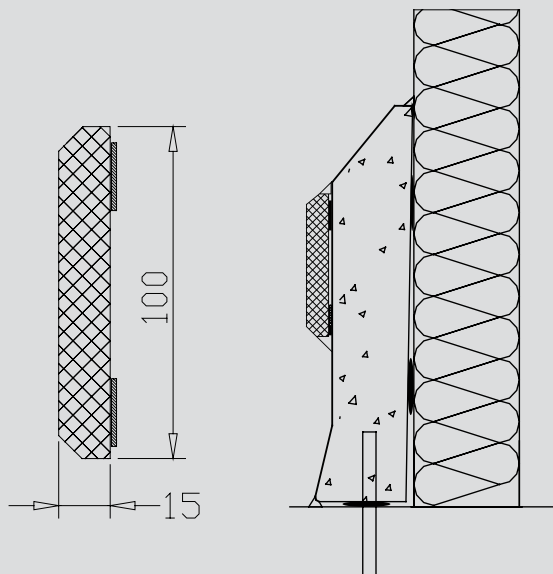

O banda de protectie din polietilena instalata pe o bordura au ca rezultat cea mai buna protectie la socuri si lovituri repetate.

O banda de protectie din polietilena poate fi montata foarte rapid pe bordurile noastre PolySto utilizand autoadeziv pe spatele benzii de protectie sau prin fixare mecanica cu suruburi din otel inoxidabil.

POLYSTO STALPI INOX AISI 304L



MONTAJ PE PARDOSEALA BRUTA

Protejati-va infrastructura, usile si utilajele industriale in egala masura utilizand protectii tubulare din inox.

PolySto stalpi si bariere de protectie sunt umplute cu beton pentru a da o mai mare rezistenta si obturate cu rasina-quartz pentru a evita absorbtia lichidelor.

Aspect: Mat-microsferic - patinat



PolySto stalpi inox carotati si PolySto OP10F instalata pe pardoseala beton.

POLYSTO BARIERA DE PROTECTIE INOX AISI 304L

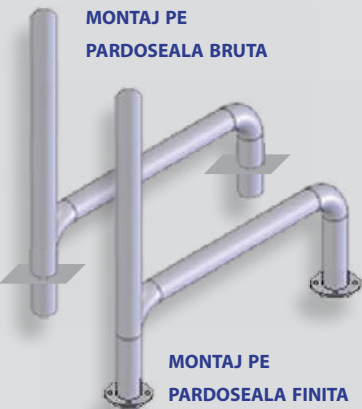

PolySto bariera de protectie ofera o protectie solida pentru toate usile d-voastra.

Calitate: AISI 304L

Diametru recomandat:

104 mm



204 mm



Toate diametrele sunt posibile la cerere!

Aspect: Mat-microsferic - patinat



Protectii PolySto din inox tubulare, carotate in pardoseala si cu rezervare pentru racord cu rasina.

POLYSTO PROTECTIE ANTISOC PENTRU SPATII INTERIOARE SI EXTERIOARE

Sistemele de securitate antisoc PolySto sunt o asigurare a investitiei in bunuri mobiliare si imobiliare ale companiei gratie solutiilor de inalta calitate tehnica si estetica.

Fiecare dispozitiv beneficiaza de un finisaj al suprafetei tratata anticoroziv cu vopseluri speciale rezistente la intemperii si culori reflectorizante pentru o buna vizibilitate, chiar pe timp de noapte.



PolySto PMA (stanga) si PML(dreapta) montate pe o pardoseala din beton.

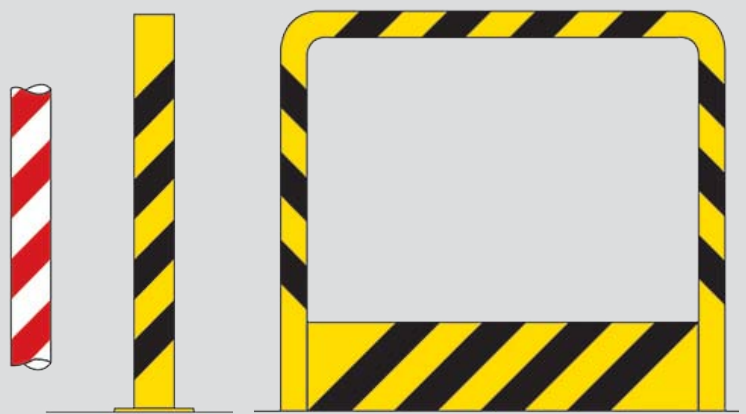

CARACTERISTICI



Castig de timp



Inalta rezistenta
mecanica



Castig de bani



Conform metodelor
HACCP



Anti-bacterian



Impermeabil



Rezistenta la foc



Reparabile



Inalta rezistenta
la agenti chimici



Sistem prefabricat



Rezistent la inghet



Disponibil in
toate culorile RAL



Castig de spatiu



Uşor de curăţat

APLICATII

Industria de prelucrare carne - Abbatoirs - Industrie Prelucrare peşte - Industria produselor lactate - Bauturi - Fructe și legume - industria de patiserie - Supermarketuri - Congelatoare - Logistica - Catering - Restaurante - Industria farmaceutica - Spitale - Brutării industriale - Cosmetice - Tutun - industria chimică - congelatoare - industria electrotehnica, ...



PolySto IP40F Sanicoat montata pe pardoseala de beton cu stalpi si bariere de protectie din inox.



PolySto OP20F montata pe o pardoseala din rasina.



PolySto OP30F, OP30SF Sanicoat si un stalp poliuretan montate pe pardoseala de rasina.



PolySto OP30RB Sanicoat cu degajare pentru racordarea la pardoseala de rasina.